

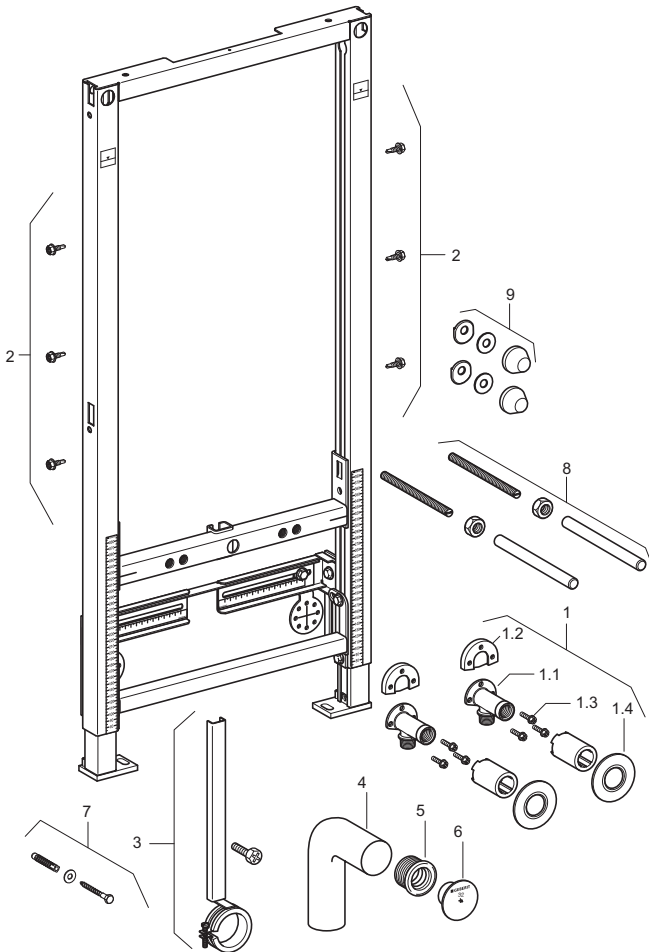

## Replacement Parts for Wall-Hung Bidet Carrier 111.510.00.1

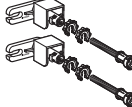

Item No.	Model No.	Description	List Price
1	465.034.00.1	Elbow supply fitting set, Gun Metal	\$33.00
1.1	602.287.00.1	Fitting body, Gun Metal	23.00
1.2	601.802.00.1	Sound insulation base, EPDM	2.00
1.3	216.197.00.1	Mounting Screws for water supply, self tapping	2.00
1.4	240.243.00.1	Seal washer, EPDM, 26 mm	3.00
2	111.892.00.1	Frame mounting screws for steel stud construction, Galvanized; self-tapping	3.00
3	241.066.00.1	Pipe Mounting Bracket	14.00
4	241.067.16.1	Outlet bend – 90 degrees, Ø32 mm	12.00
5	152.682.00.1	Outlet Seal, EPDM, push on for Ø50 mm tube	3.00
6	240.306.00.1	Connection Plug, Ø32 mm	2.00
7	216.179.00.1	Installation Hardware	3.00
8	240.189.00.1	Threaded rod for wall-mounted toilet or bidet installation, M12 x 7" (18 cm)	4.00
9	217.713.46.1	Cover caps with leveling washer, Plastic, Matte chrome	5.00

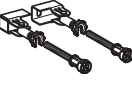
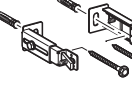
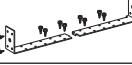

### Mounting Accessories for Carrier Frames

Description	Model No.	List Price
 Frame to wall anchoring for 5.12"–7.87" (13–20 cm) thick unfinished pre-wall	111.815.00.1	\$30.00
 Frame to wall anchoring for 5.12"–7.87" (13–20 cm) thick unfinished pre-wall corner installations	111.835.00.1	30.00
 Frame to wall anchoring where foot installations into floor are not allowed for 5.12"–7.87" (13–20 cm) thick unfinished pre-wall	111.867.00.1	61.00
 Frame to stud fastening set for extended stud spacing from 19.75"–25.56" (50–65 cm)	111.869.00.1	30.00
 Frame to wall anchoring extensions for 7.87"–15.75" (20–40 cm) thick unfinished pre-wall	111.887.00.1	11.00

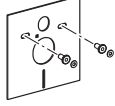
### Bowl Connection Accessories

 Acoustic insulation set for wall-hung toilets and bidets	156.050.00.1	\$15.00
 Cover caps with leveling washer, Plastic, Alpine white	217.713.11.1	5.00

### Required Accessories for 3.54"–7.09" (9–18 cm) Finished Wall Thickness

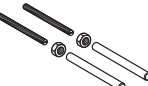
 Mounting rod extension set for wall-hung toilet and bidet, M12	242.232.00.1	20.00
--	--------------	-------