

Inactive* System Replacement Parts

Replacement Parts for Wall-Hung Washdown Toilet Carrier 111.335.00.1 and 111.335.00.2

Item No.	Model No.	Description	List Price
1	240.930.00.1	Splash guard protection cover for UP300	\$6.00
2	240.931.00.1	Mud guard protection housing for UP300, Plastic	9.00
3	241.829.00.1	Flush actuator gear box	6.00
4	241.469.00.1	Impuls380 Fill valve for concealed tanks	24.00
4.1	240.771.00.1	Seal kit for Impuls380 fill valve	11.00
4.2	240.923.00.1	Fixation clip for filling valve	6.00
5	240.851.00.1	Drop Ear Elbow, copper; 5/8" copper tubing x 1/2" NPT female	11.00
6	240.921.00.1	Connection hose for concealed tank, 3/8"	14.00
6	241.854.00.1	Connection hose for concealed tank, 3/8" – dezincification resistant for salt water	21.00
6.1	240.922.00.1	Seal kit for braided hose, EPDM O-Ring	9.00
7	240.853.00.1	Supply angle Stop, 1/2" NPT male	14.00
8.0	241.858.00.1	Dual-flush valve complete with valve seat basket	12.00
8.1	240.622.00.1	Dual-flush valve for concealed tank.	12.00
8.2	241.167.00.1	Yoke set for flush valves	9.00
8.3	816.418.00.1	Flat gasket for flush valve	2.00

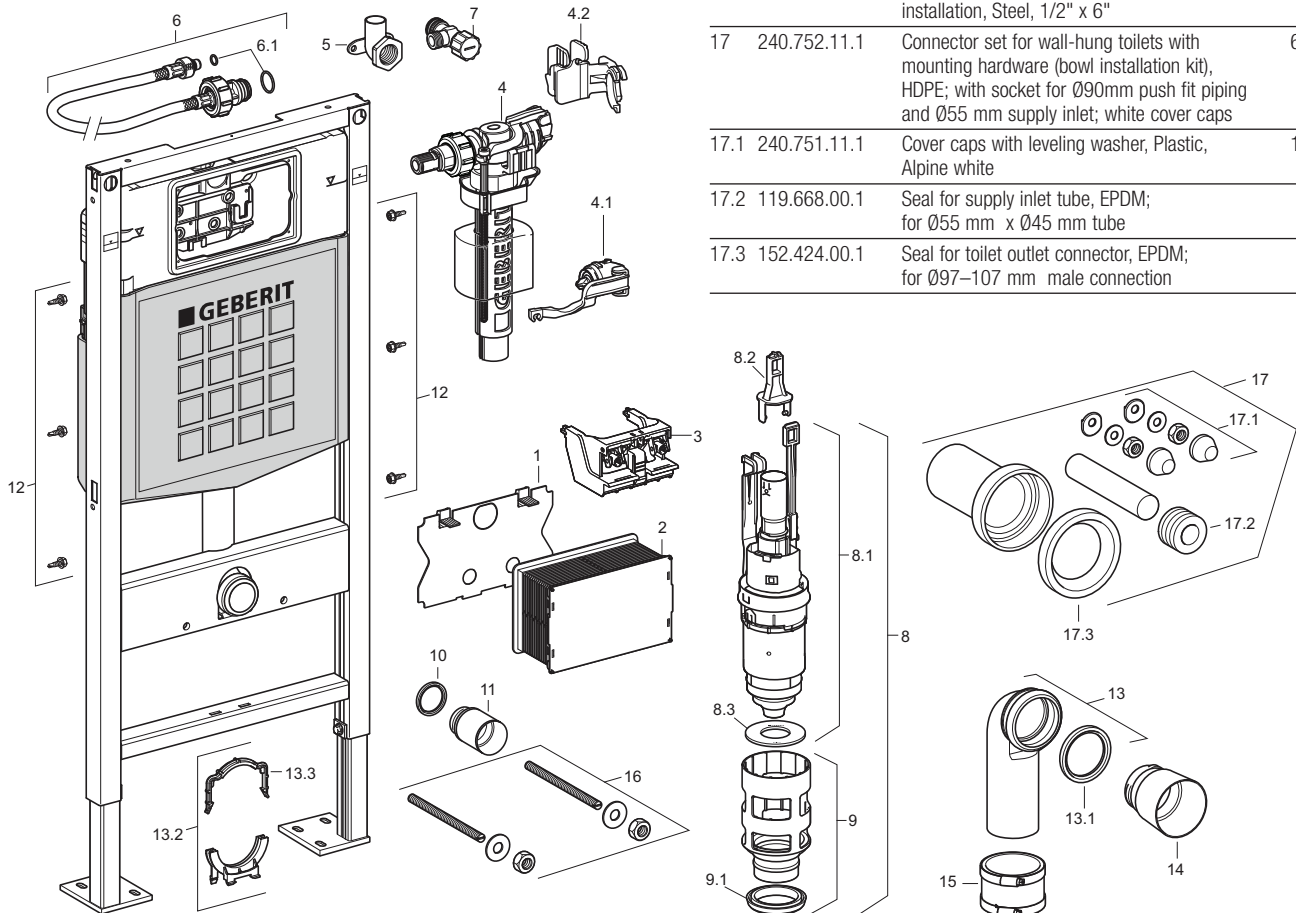

Item No.	Model No.	Description	List Price
9	241.859.00.1	Valve seat basket and noise bushing for flush valve	9.00
9.1	241.868.00.1	U-cup seal for valve basket	2.00
10	362.771.00.1	Seal for concealed flush pipe, EPDM; for Ø45 mm socket push fit piping	2.00
11	362.796.92.1	Protection plug, Plastic; for Ø45 mm socket push fit piping	5.00
12	111.892.00.1	Frame mounting screws for steel stud construction, Galvanized; self-tapping	3.00
13	366.061.16.1	Waste fitting outlet bend, HDPE; 1 x 90° bend with socket for Ø90 mm push fit piping and Ø90 mm outlet	18.00
13.1	387.282.00.1	Seal for outlet bends, EPDM; for Ø90 socket push fit piping	5.00
13.2	240.972.00.1	Outlet pipe bracket (complete)	6.00
13.3	240.417.00.1	Outlet pipe bracket handle	5.00
14	366.820.92.1	Protection plug, Plastic; for Ø90 socket push fit piping	4.00
15	240.782.00.1	Flexible Coupling for pipes, 3" CI to 3" PL, ST or XH CI; 2-band	62.00
16	240.780.00.1	Threaded rods for wall-mounted toilet installation, Steel, 1/2" x 6"	19.00
17	240.752.11.1	Connector set for wall-hung toilets with mounting hardware (bowl installation kit), HDPE; with socket for Ø90mm push fit piping and Ø55 mm supply inlet; white cover caps	69.00
17.1	240.751.11.1	Cover caps with leveling washer, Plastic, Alpine white	14.00
17.2	119.668.00.1	Seal for supply inlet tube, EPDM; for Ø55 mm x Ø45 mm tube	2.00
17.3	152.424.00.1	Seal for toilet outlet connector, EPDM; for Ø97–107 mm male connection	3.00



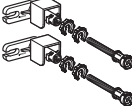
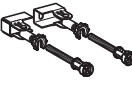
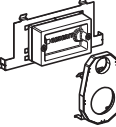
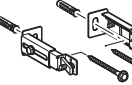
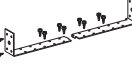

* Inactive since 01/09

Optional Replacement Parts for Wall-Hung Washdown Toilet Carrier 111.335.00.1



Mounting Accessories for Carrier Frames

Description	Model No.	List Price
 Frame to wall anchoring for 5.12"–7.87" (13–20 cm) thick unfinished pre-wall	111.815.00.1	\$30.00
 Frame to wall anchoring for 5.12"–7.87" (13–20 cm) thick unfinished pre-wall corner installations	111.835.00.1	30.00
 Fire protection set for UP300 concealed dual-flush tanks; 60 min. fire resistance to DIN EN 1364-1:1999-10	111.862.00.1	464.00
 Frame to wall anchoring where foot installations into floor are not allowed for 5.12"–7.87" (13–20 cm) thick unfinished pre-wall	111.867.00.1	61.00
 Frame to stud fastening set for extended stud spacing from 19.75"–25.56" (50–65 cm)	111.869.00.1	30.00
 Frame to wall anchoring extensions for 7.87"–15.75" (20–40 cm) thick unfinished pre-wall	111.887.00.1	11.00
 Mounting rod for 1/2" to M12 for toggle-lock mountings	242.213.00.1	20.00

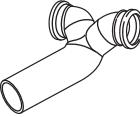

Waste Fittings

 HDPE straight connector with socket for Ø3.54" (Ø90 mm) push fit piping and Ø3.54" (Ø90 mm) outlet x 12" (31 cm) long	366.887.16.1	27.00
 Cast iron outlet bend; 1 x 90° bend with socket for Ø3.54" (Ø90 mm) push fit piping and 3" CIP outlet	367.071.18.1	127.00

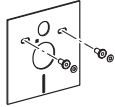

Mounting Accessories for Carrier Frames (continued)

Description	Model No.	List Price
 HDPE "Back-to-back" connector for horizontal drain connections; 2 x 90° bends with sockets for Ø3.54" (Ø90 mm) push fit piping, with 45° offset and expansion to Ø4.33" (Ø110 mm) outlet	367.485.16.1	\$127.00
 HDPE "Back-to-back" connector for vertical drain connections; 2 x 90° bends with sockets for Ø3.54" (Ø90 mm) push fit piping and expansion to Ø4.33" (Ø110 mm) outlet	367.923.16.1	127.00

Bowl Connection Sets and Accessories

 HDPE connection set with 1" (2.5 cm) offset and mounting hardware (bowl installation kit); with socket for Ø3.54" (Ø90 mm) push fit piping and Ø55 mm supply inlet; matte chrome cover caps	405.116.00.1	205.00
 Acoustic insulation set for wall-hung toilets and bidets	156.050.00.1	15.00
 Cover caps with leveling washer, Alpine white	217.713.11.1	5.00

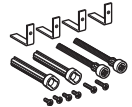
Required Accessories for 3.54"–7.09" (9–18 cm) Finished Wall Thickness

 Mud guard protection housing for UP300 flush tanks	240.931.00.1	9.00
 Extension set for actuator flush plates compatible with UP320, UP300, and UP200 flush tanks	240.938.00.1	19.00
 HDPE Connector set for extended installation and mounting hardware (bowl installation kit), with socket for Ø3.54" (Ø90 mm) push fit piping and Ø55 mm supply inlet; matte chrome cover caps	152.438.46.1	50.00
Note: Order with 240.751.11.1 for 1/2" hardware. See Item No. 17.1 on previous page.		14.00