

Wall-Hung Washdown Toilet Carrier

Replacement Parts for Wall-Hung Washdown Toilet Carrier 110.816.00.1*

Item No.	Model No.	Description	List Price
1	241.469.00.1	Impuls380 fill valve for concealed tanks	\$24.00
1.1	240.771.00.1	Seal kit for Impuls380 fill valve	11.00
2	240.069.00.1	Connection hose for concealed tank	16.00
3	240.114.00.1	Flush valve Universal for concealed tank	30.00
3.1	816.418.00.1	Flat gasket for flush valve	2.00
3.2	241.167.00.1	Yoke set for flush valves	9.00
3.3	241.170.00.1	Fixing bracket for Universal flush valve	9.00
4	240.195.00.1	Valve seat basket for flush valve	6.00
4.1	240.282.00.1	U-cup seal for valve basket	2.00
5	240.076.00.1	Flush actuator gear box	6.00
6	240.073.00.1	Splash guard protection cover for Highline and 200F	6.00
6.1	240.074.00.1	Actuator rod for Twinline, 200F, Highline	2.00
7	240.233.00.1	Mud guard protection housing for Highline, 200F, Twinline, Plastic	19.00

Item No.	Model No.	Description	List Price
8	240.853.00.1	Supply angle Stop	\$14.00
8.1	240.851.00.1	Drop Ear Elbow, Copper	11.00
9	362.771.00.1	Seal for concealed flush pipe, EPDM	2.00
9.1	362.796.92.1	Protection plug, Plastic	5.00
10	240.780.00.1	Threaded rods for wall-mounted toilet installation, Steel	19.00
11	240.781.00.1	Outlet pipe bracket (complete)	14.00
12	366.061.16.1	Waste fitting outlet bend, HDPE	18.00
12.1	387.282.00.1	Seal for outlet bends, EPDM	5.00
13	366.820.92.1	Protection plug, Plastic	4.00
14	240.782.00.1	Flexible Coupling for pipes	62.00
15	240.752.11.1	Connector set for wall-hung toilets with mounting hardware (bowl installation kit), Plastic, White cover caps	69.00
15.1	240.751.11.1	Cover caps with leveling washer, Plastic, Alpine White	14.00
15.2	119.668.00.1	Seal for supply inlet tube, EPDM	2.00
15.3	152.424.00.1	Seal for toilet outlet connector, EPDM	3.00

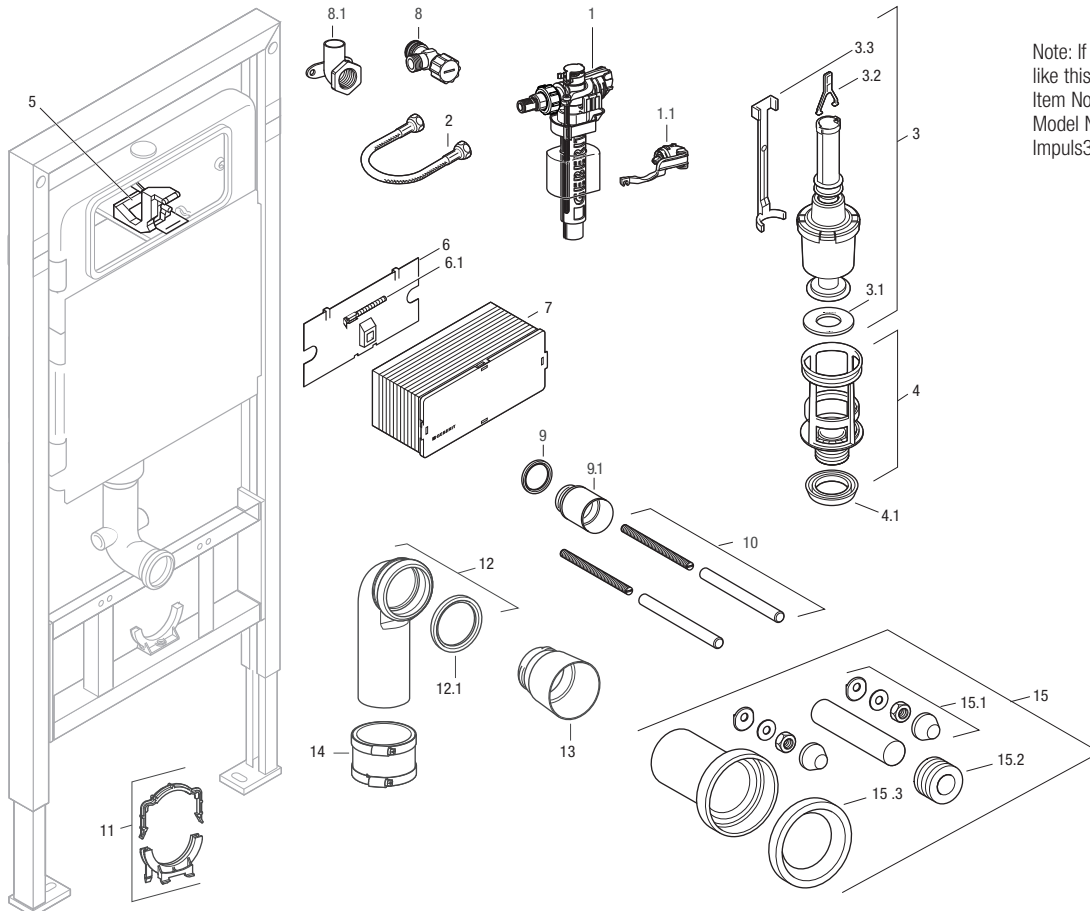

Note: If your fill valve looks like this, replace with Item No. 1, Model No. 241.469.00.1, Impuls380 fill valve



* Inactive since 12/06



Wall-Hung Washdown Toilet Carrier

Replacement Accessories for Wall-Hung Washdown Toilet Carrier 110.816.00.1*



Mounting Accessories for Carrier Frames

Description	Model No.	List Price
 Mounting rod for 1/2" to M12 for toggle-lock mountings	242.213.00.1	\$20.00

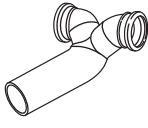
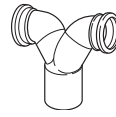

Waste Fittings

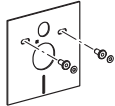
 HDPE straight connector with socket for Ø3.54" (Ø90 mm) push fit piping and Ø3.54" (Ø90 mm) outlet x 12" (31 cm) long	366.887.16.1	27.00
 Cast iron outlet bend; 1 x 90° bend with socket for Ø3.54" (Ø90 mm) push fit piping and 3" CIP outlet	367.071.18.1	127.00
 HDPE "Back-to-back" connector for horizontal drain connections; 2 x 90° bends with sockets for Ø3.54" (Ø90 mm) push fit piping, with 45° offset and expansion to Ø4.33" (Ø110 mm) outlet	367.485.16.1	127.00
 HDPE "Back-to-back" connector for vertical drain connections; 2 x 90° bends with sockets for Ø3.54" (Ø90 mm) push fit piping and expansion to Ø4.33" (Ø110 mm) outlet	367.923.16.1	127.00

Bowl Connection Sets and Accessories

Description	Model No.	List Price
 HDPE connection set with 1" (2.5 cm) offset and mounting hardware (bowl installation kit); with socket for Ø3.54" (Ø90 mm) push fit piping and Ø2.16" (Ø55 mm) supply inlet; Matte Chrome cover caps	405.116.00.1	\$205.00
 Acoustic insulation set for wall-hung toilets and bidets	156.050.00.1	15.00
 Cover caps with leveling washer, Plastic, Alpine White	217.713.11.1	5.00

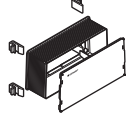
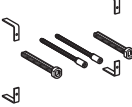
Required Accessories for 3.54"-7.09" (9-18 cm) Finished Wall Thickness

 Mud guard protection housing for Highline, 200F, Twinline, Plastic	240.233.00.1	19.00
 Extension set for actuator flush plates	240.058.00.1	24.00
 HDPE Connector set for extended installation and mounting hardware (bowl installation kit), M12 with socket for Ø3.54" (Ø90 mm) push fit piping and Ø2.16" (Ø55 mm) supply inlet; Matte Chrome cover caps	152.438.46.1	50.00
Note: Order with 240.751.11.1 for 1/2" hardware. See Item No. 15.1 on previous page.		14.00

Flush Actuators

See Actuator/Carrier Quick Reference Guide for compatible actuators

* Inactive since 12/06